

**Culottes**

Project design © Love Productions 2016  
This design is protected by copyright and  
must not be made for resale.

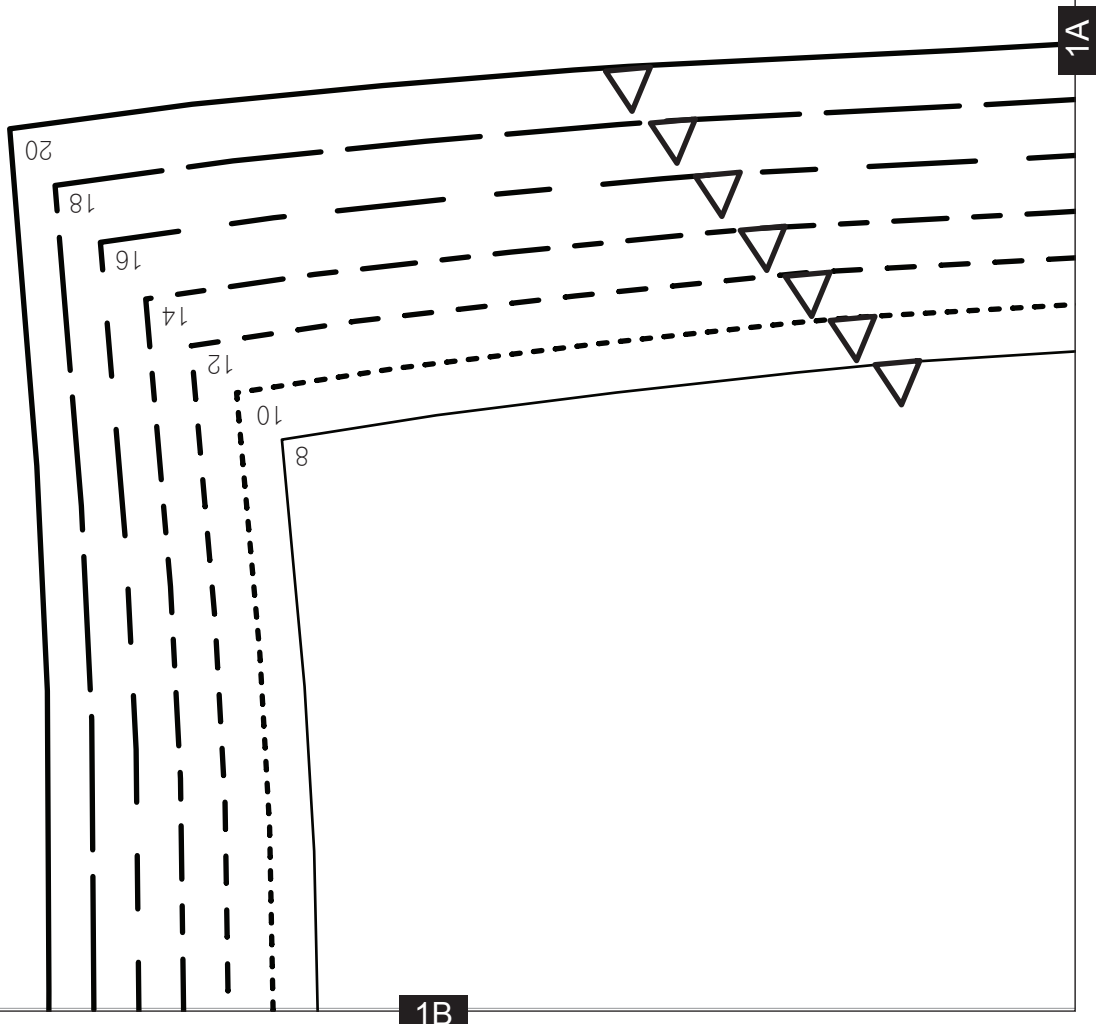

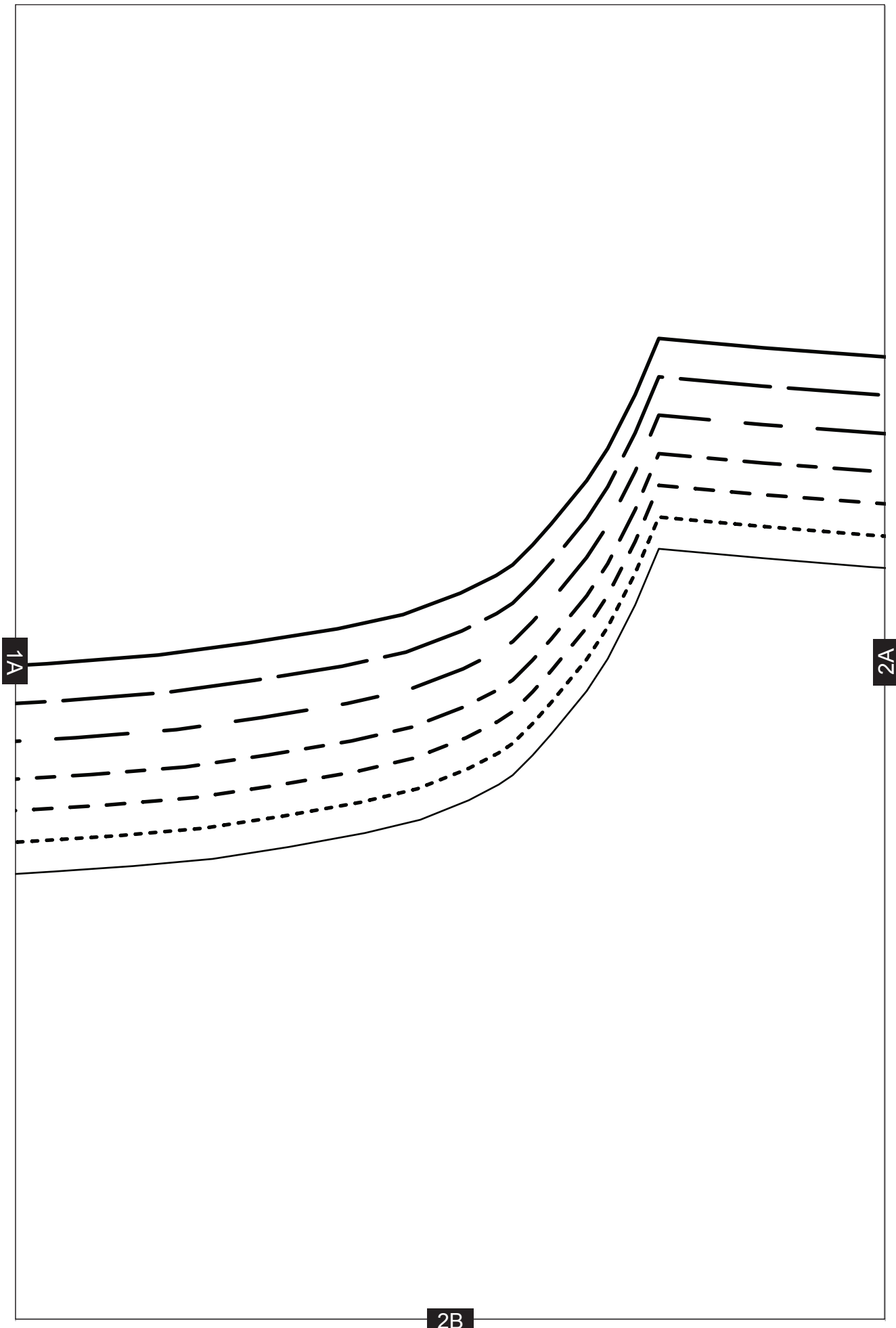

1A

2A

2B

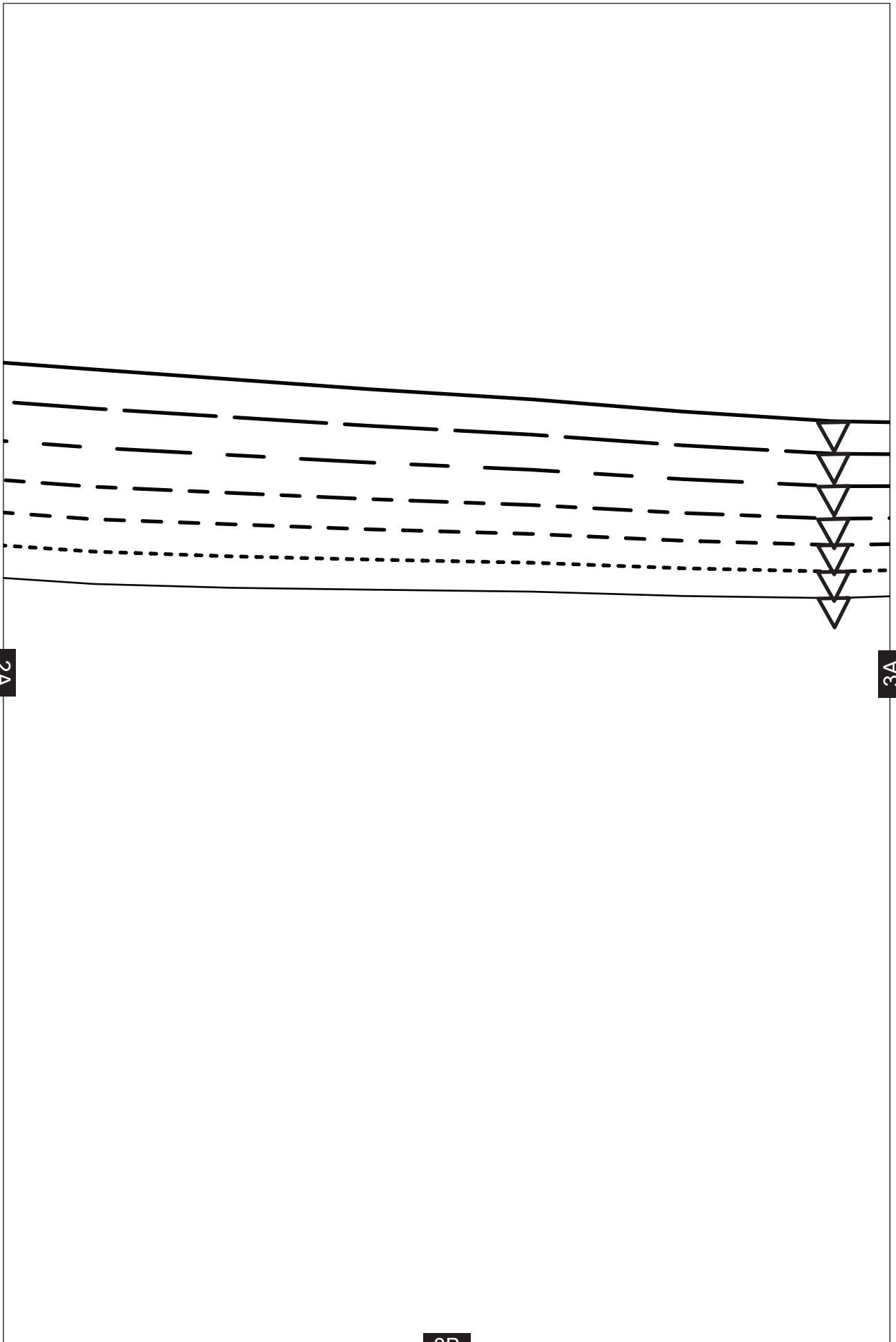

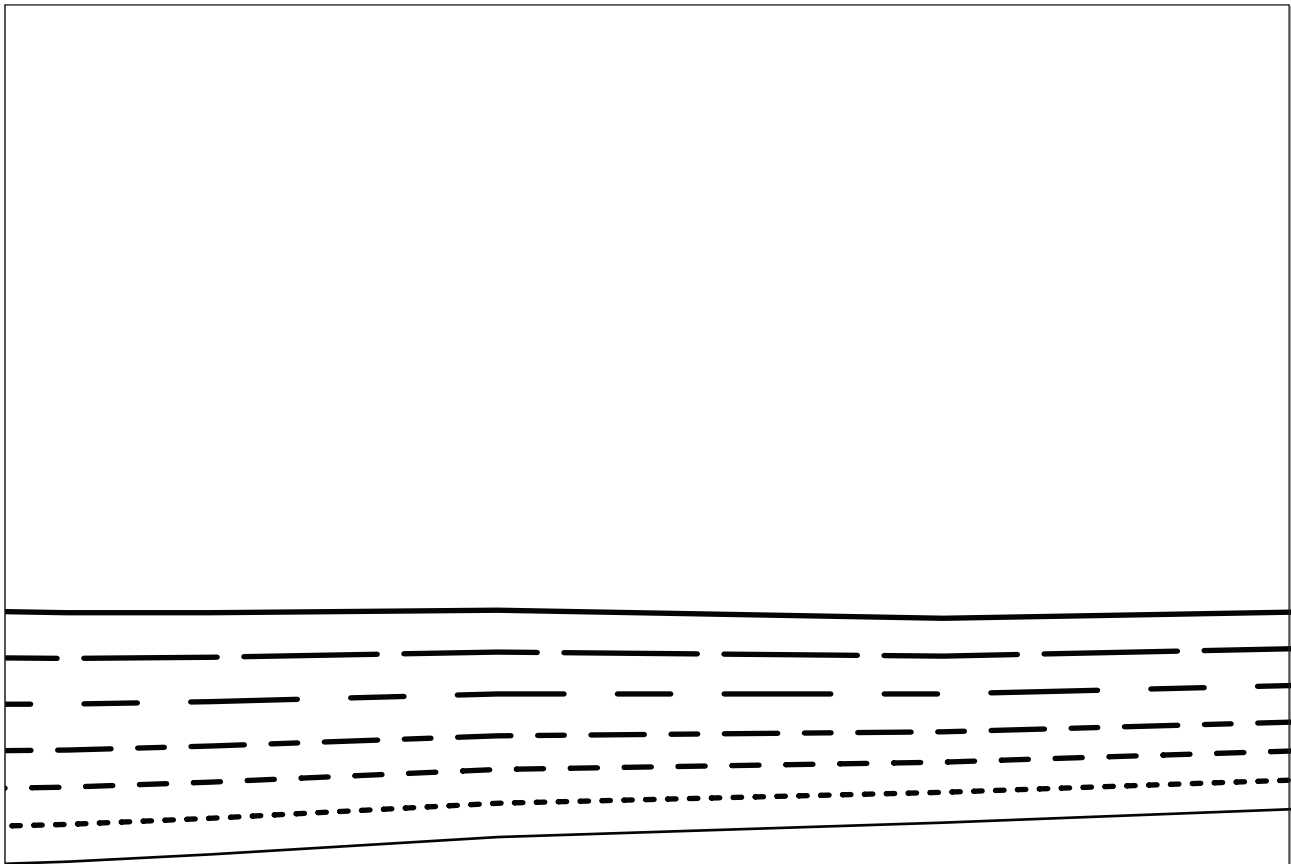

3A

4A

CULOTTES  
FRONT – CUT 2

4B

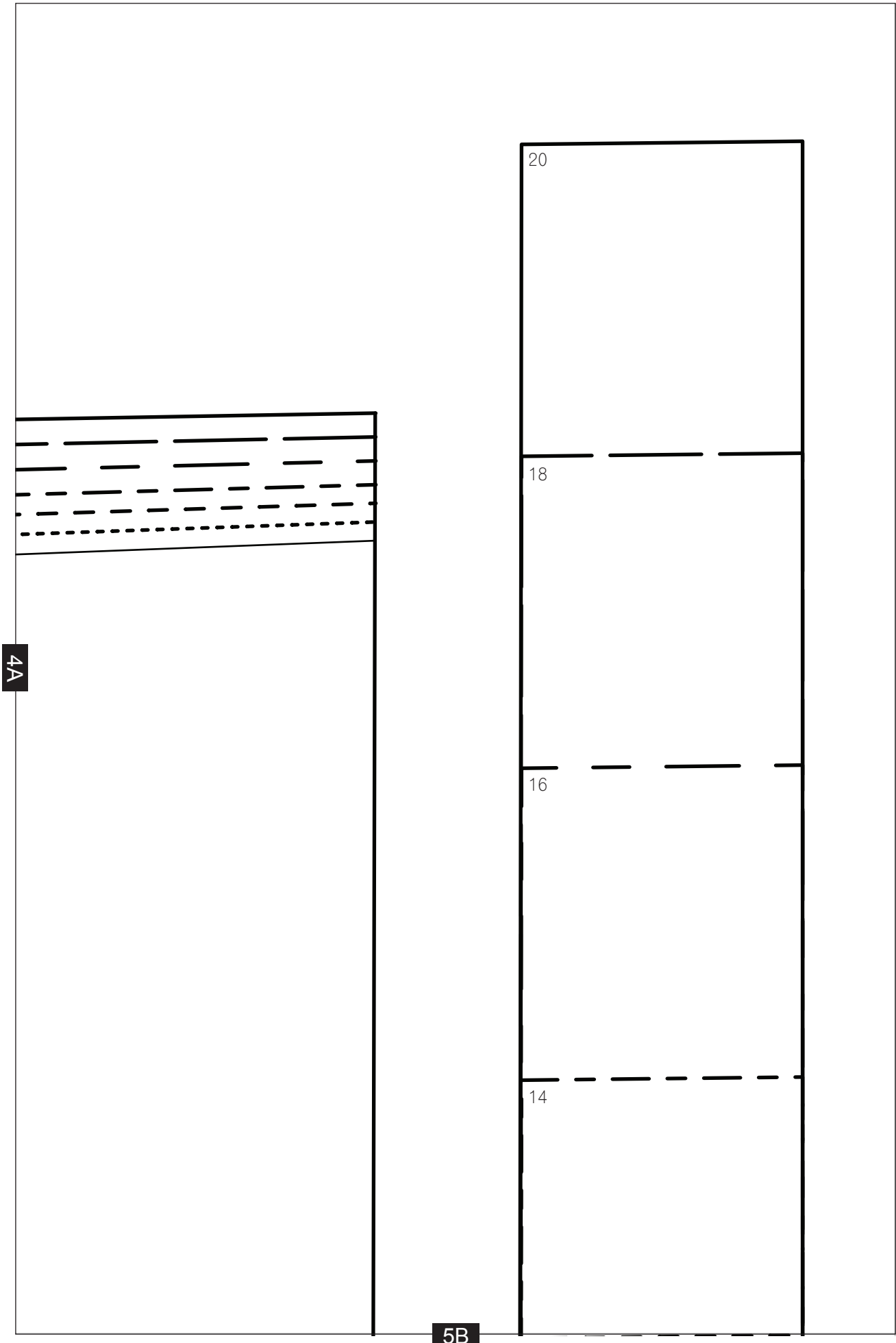

4A

20

18

16

14

5B

1B

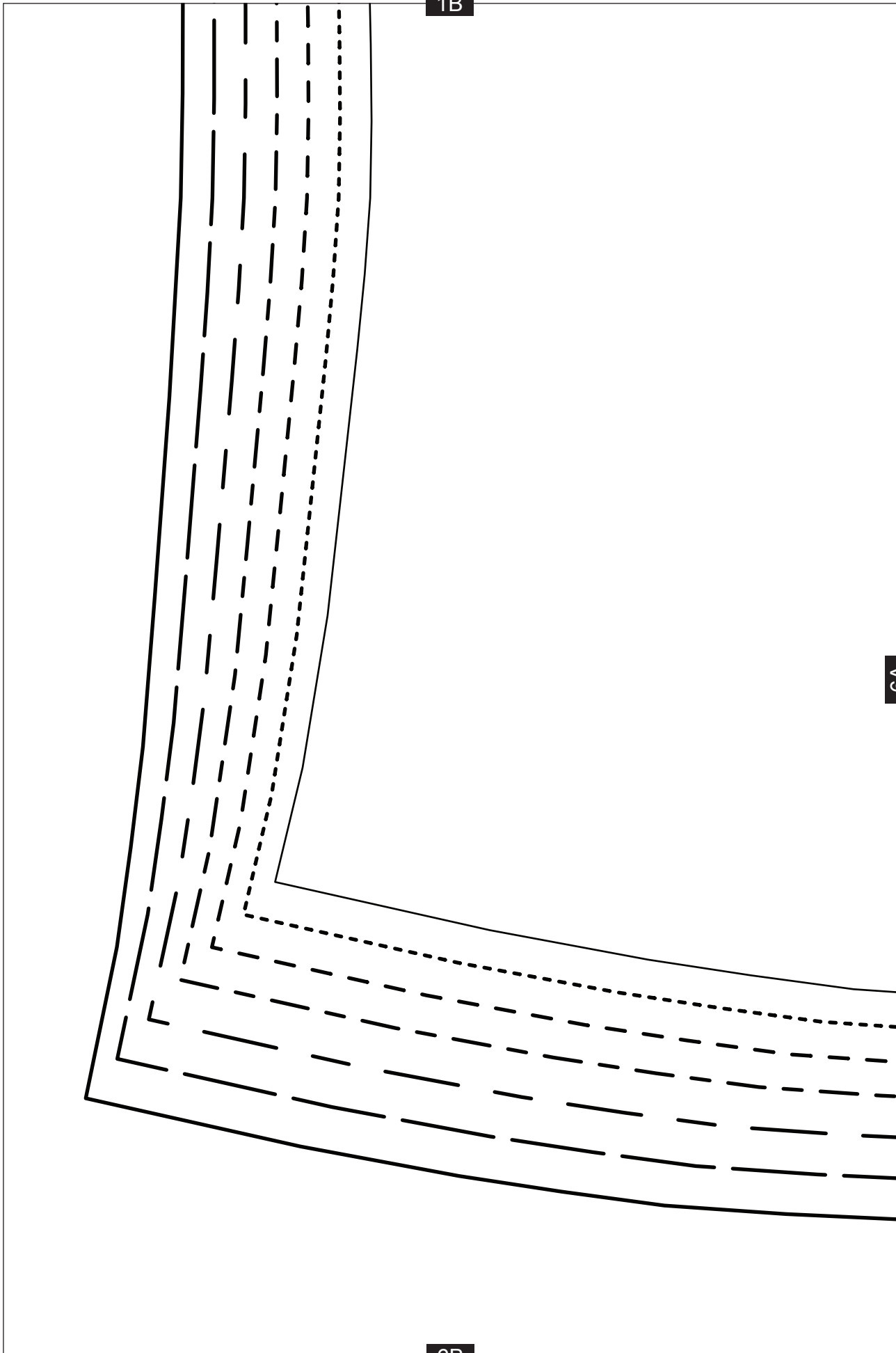

6A

6B

2B

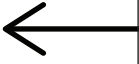

6A

7A

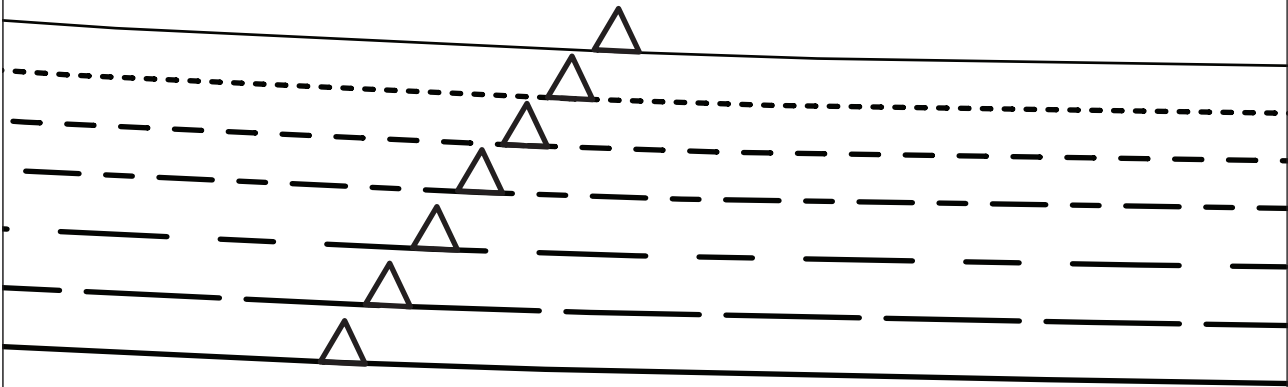

7B

3B

7A

8A

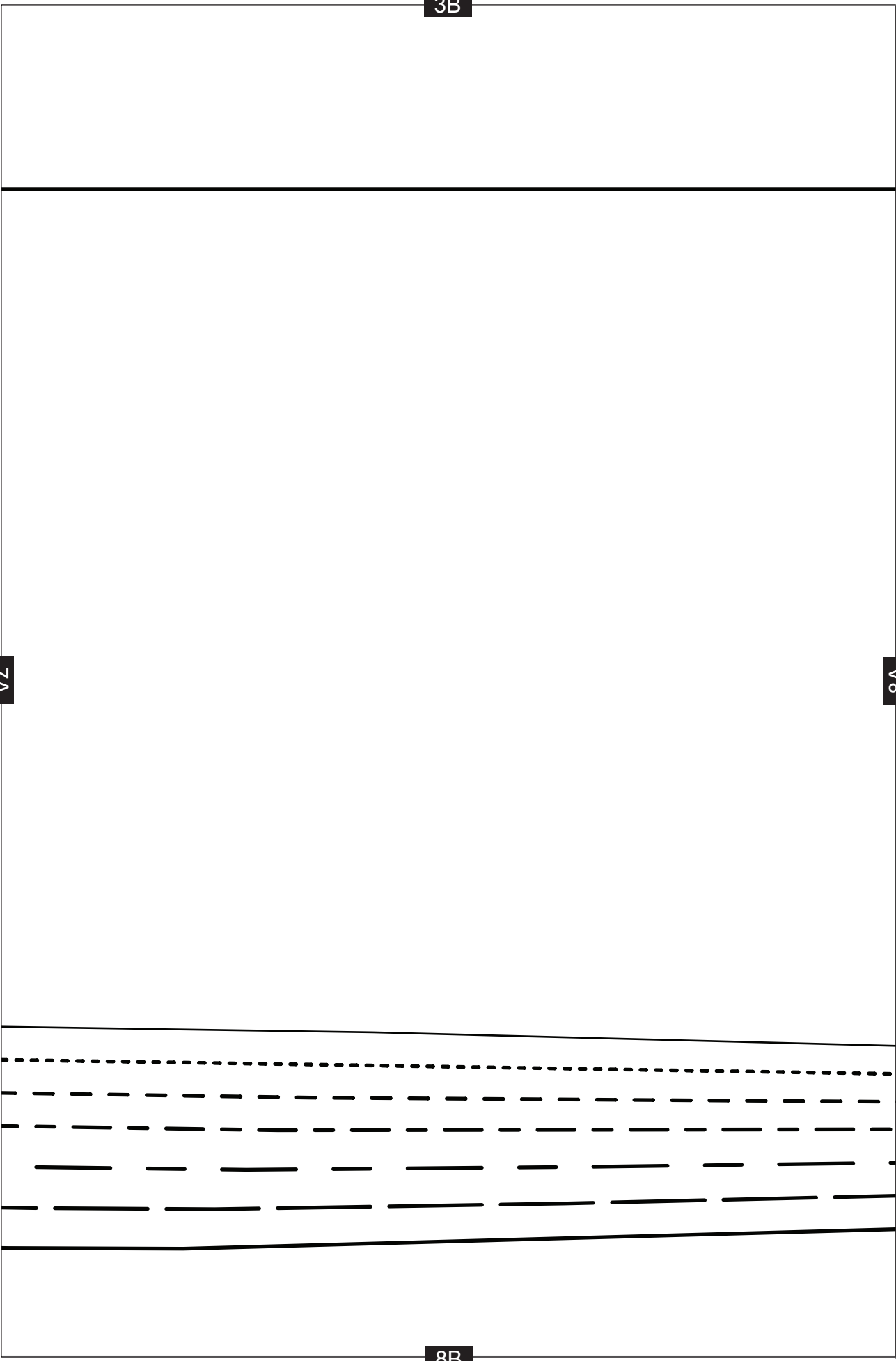

8B



4B



8A

9A

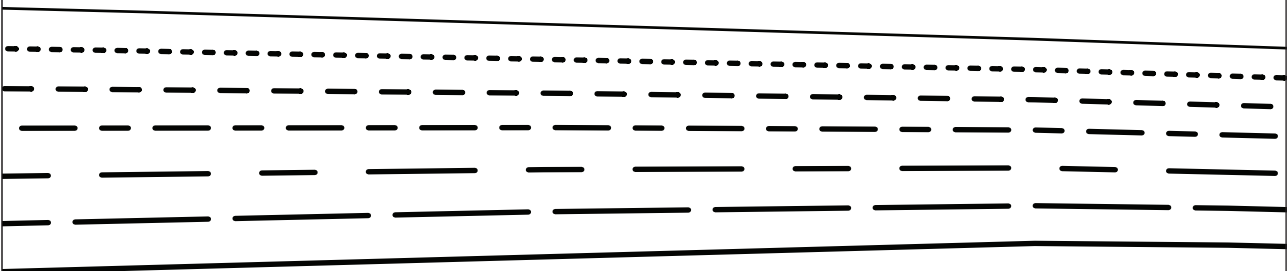

9B

9A

3.5 CM (1 1/8 IN.) HEM

5B

12

10

8

10B



6B

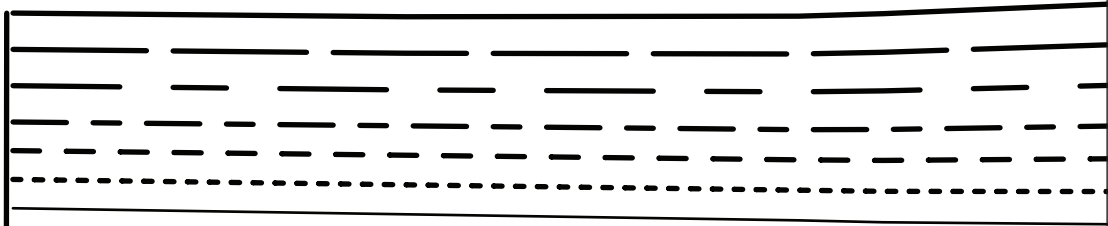

11A

11B

7B

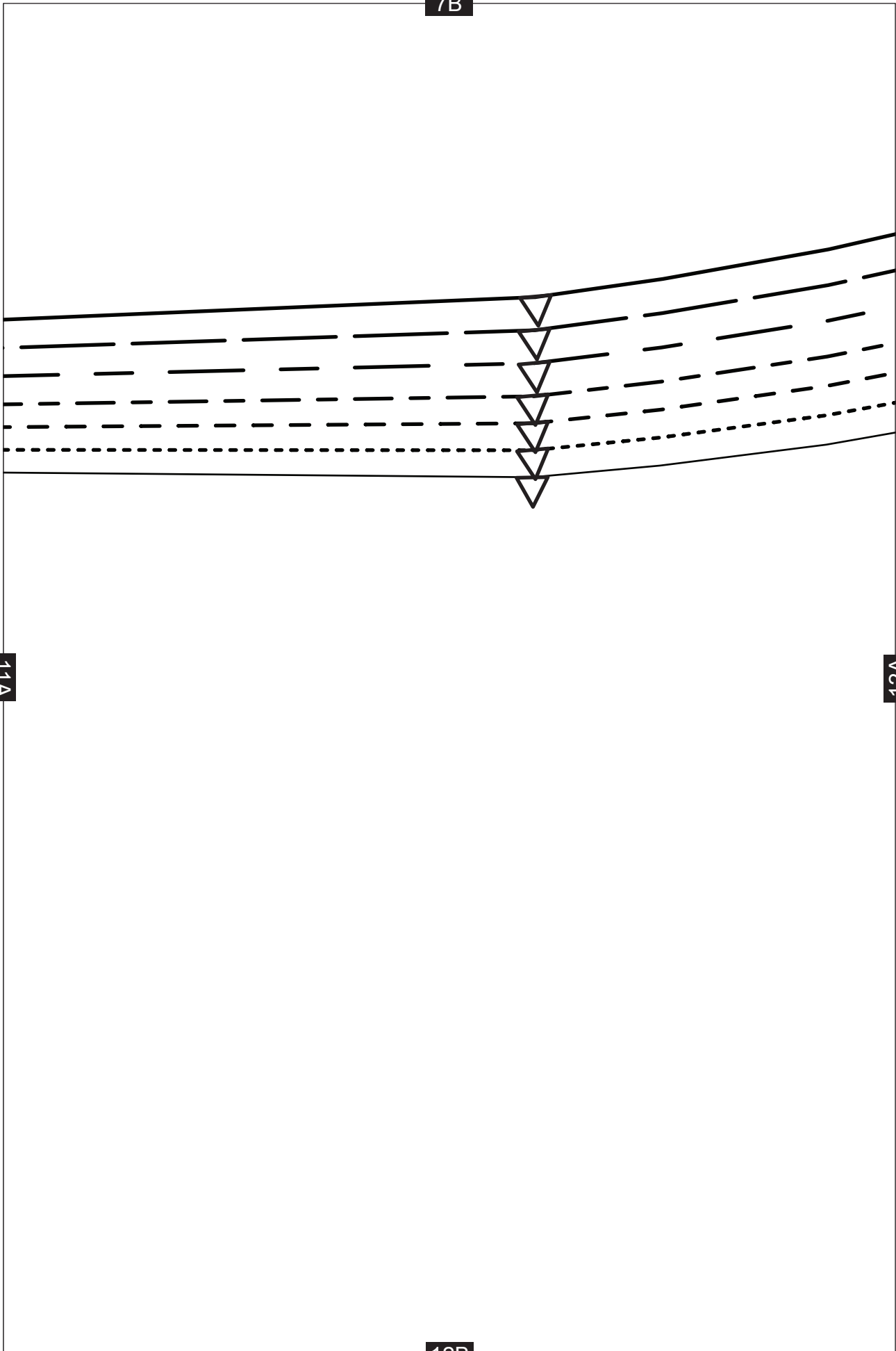

11A

12A

12B

8B

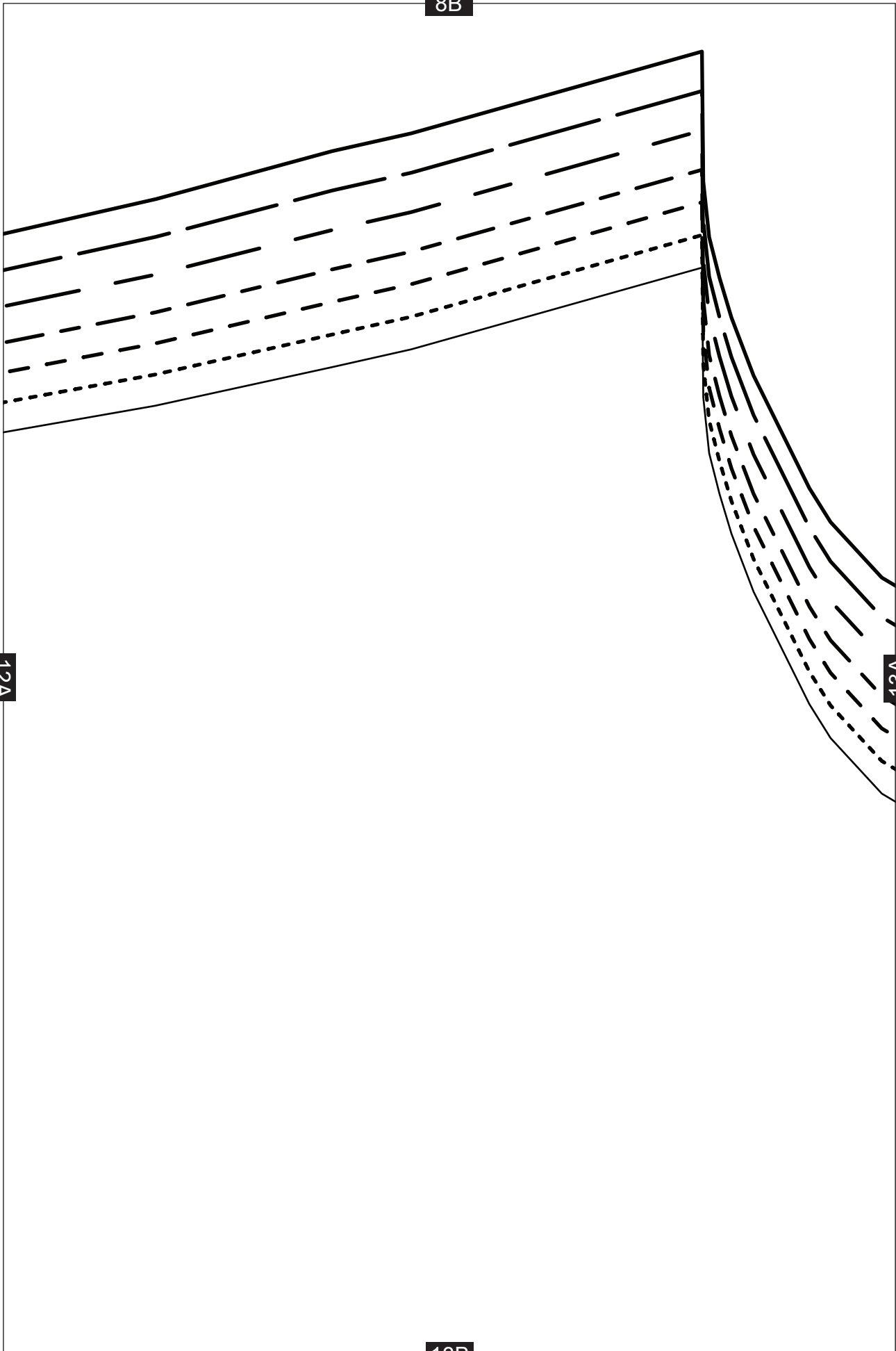

12A

13A

13B

9B

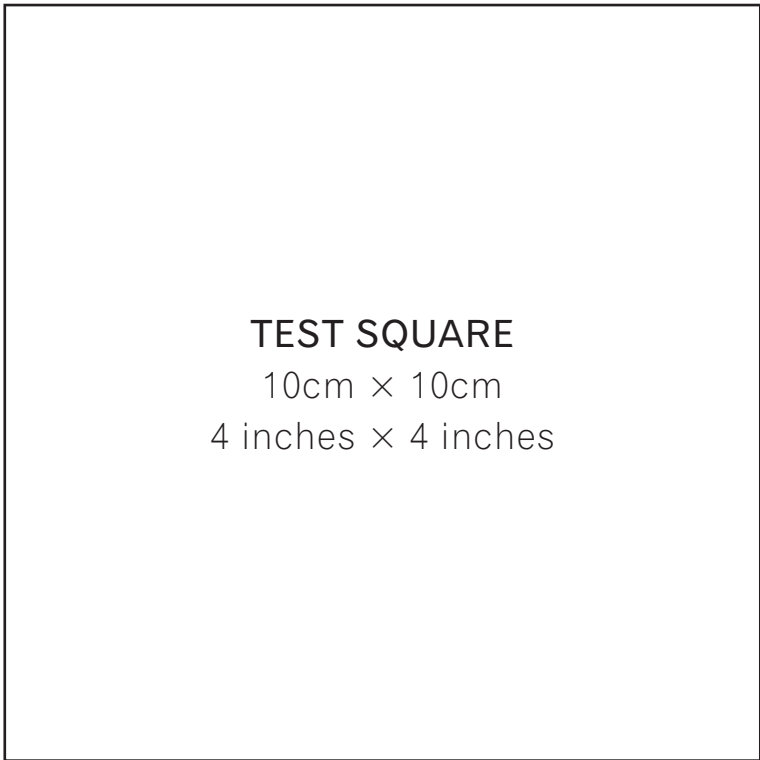

13A

14A

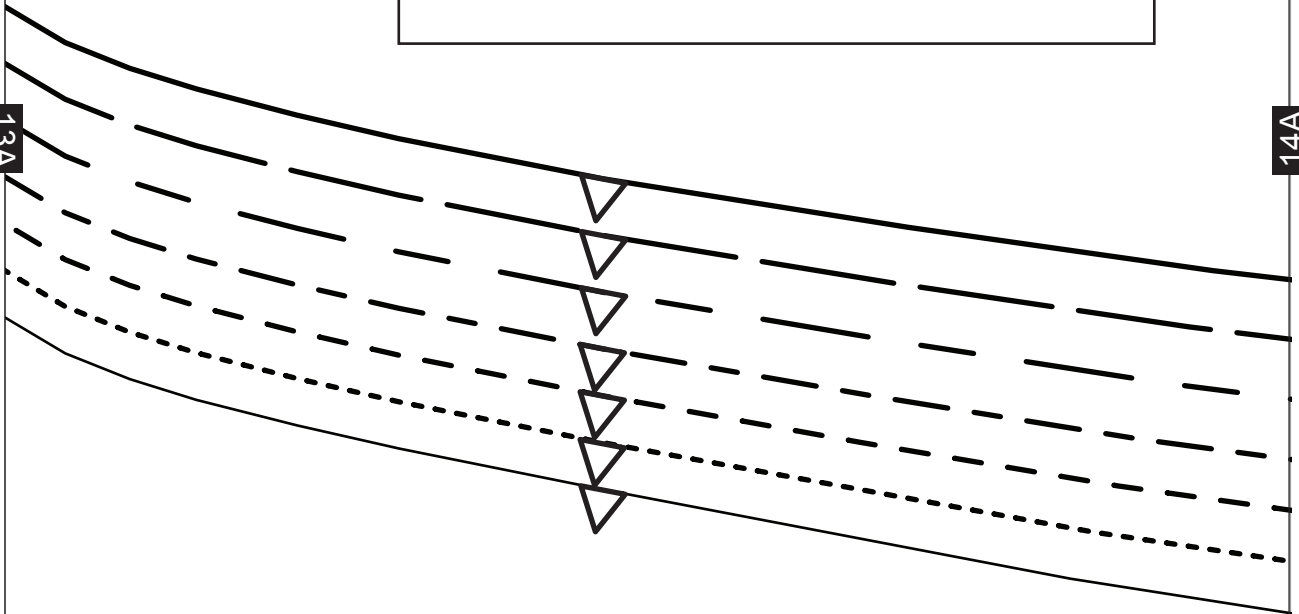

14B

10B

14A

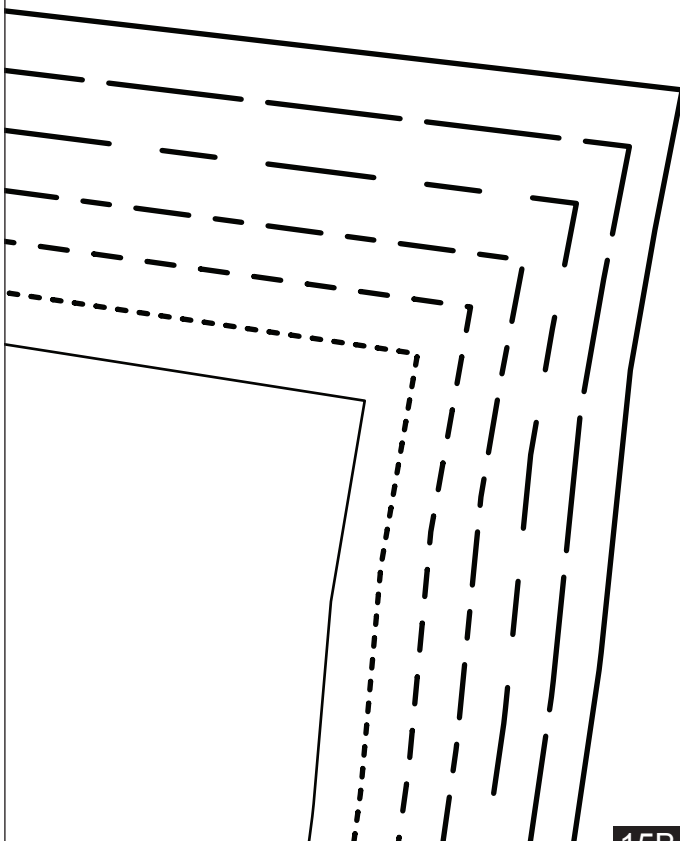

15B

11B

3.5 CM (1 1/2 IN.) HEM



16A

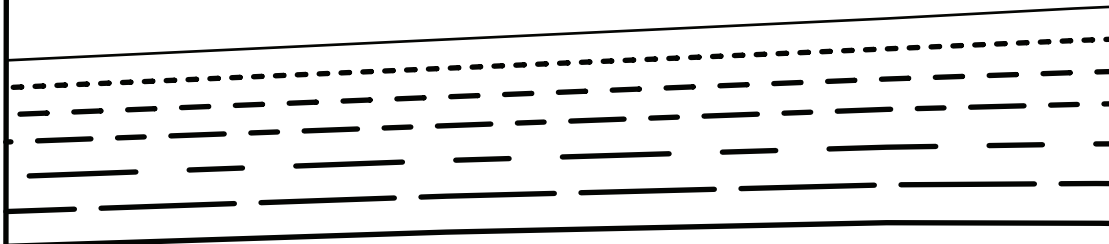



12B

CULOTTES  
BACK - CUT 2

16A

17A

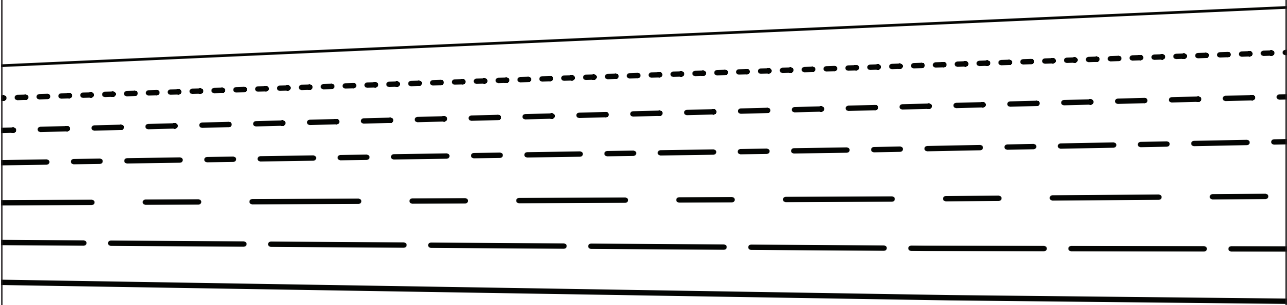

13B

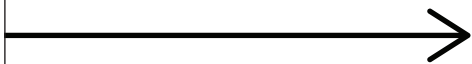

17A

18A

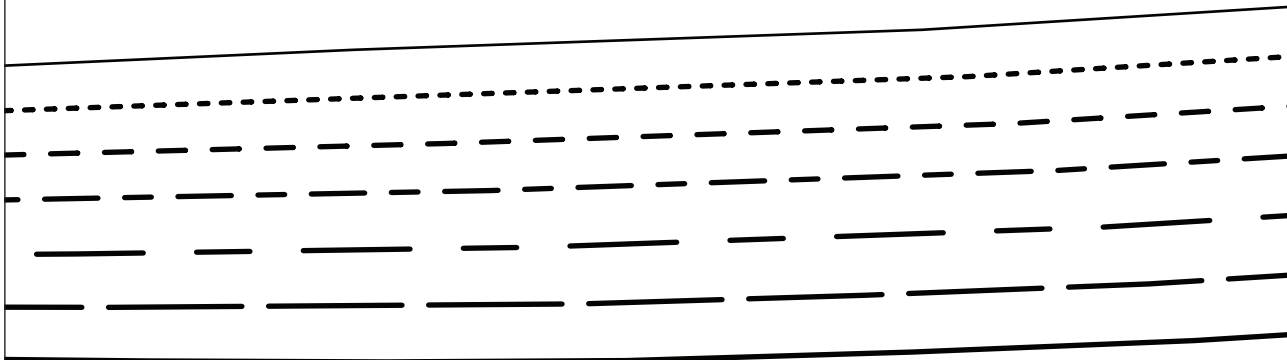

14B



18A

19A

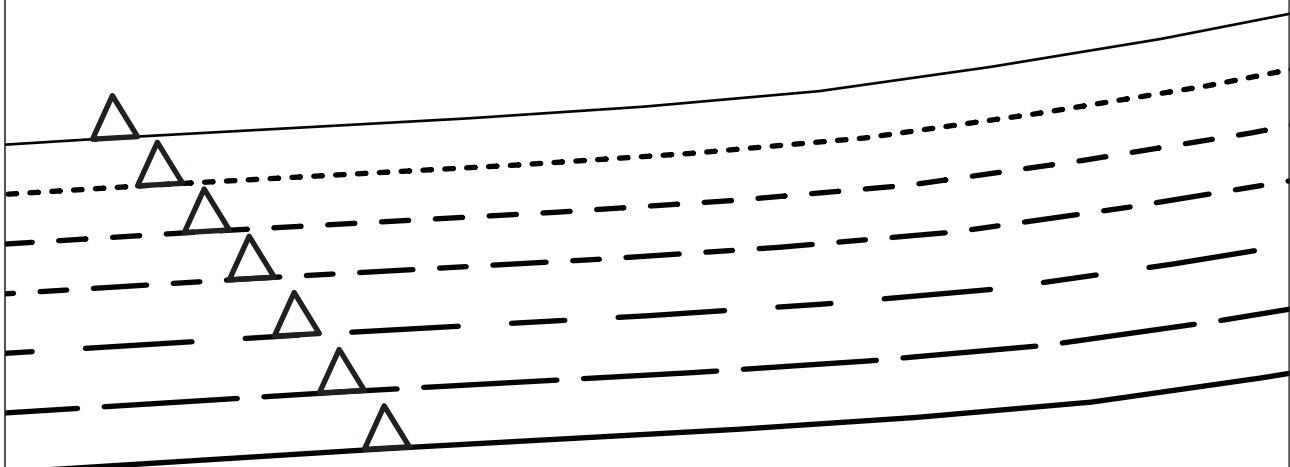

19B

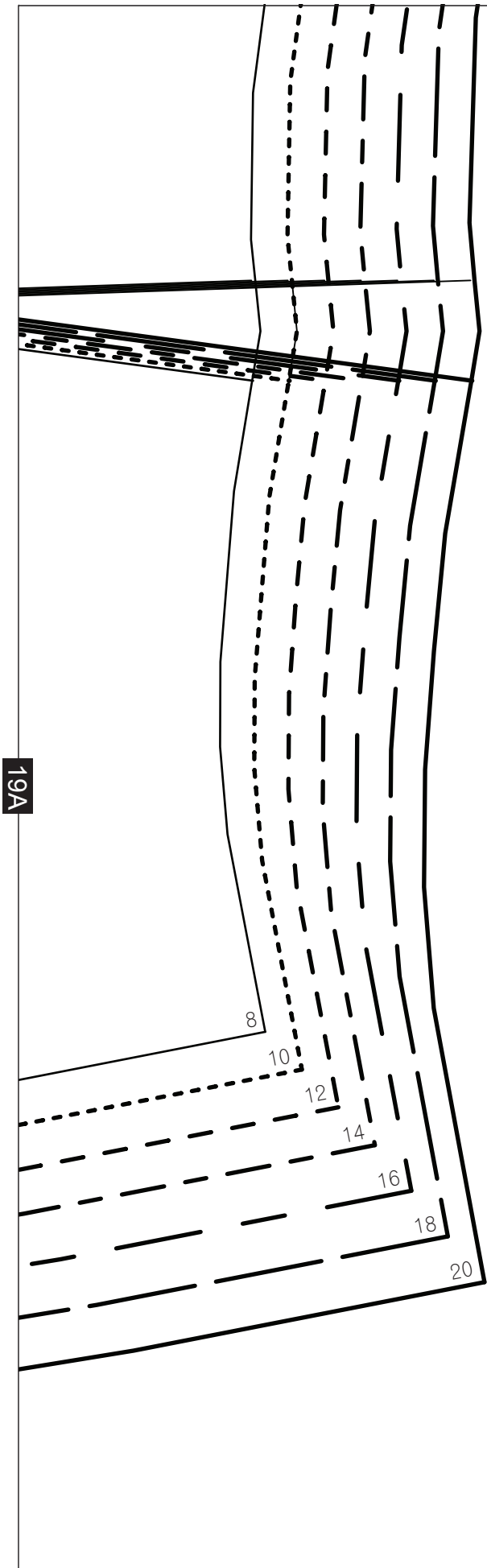

↓

CULOTTES  
WAISTBAND – CUT 1 FABRIC  
AND 1 INTERFACING

20B

19B

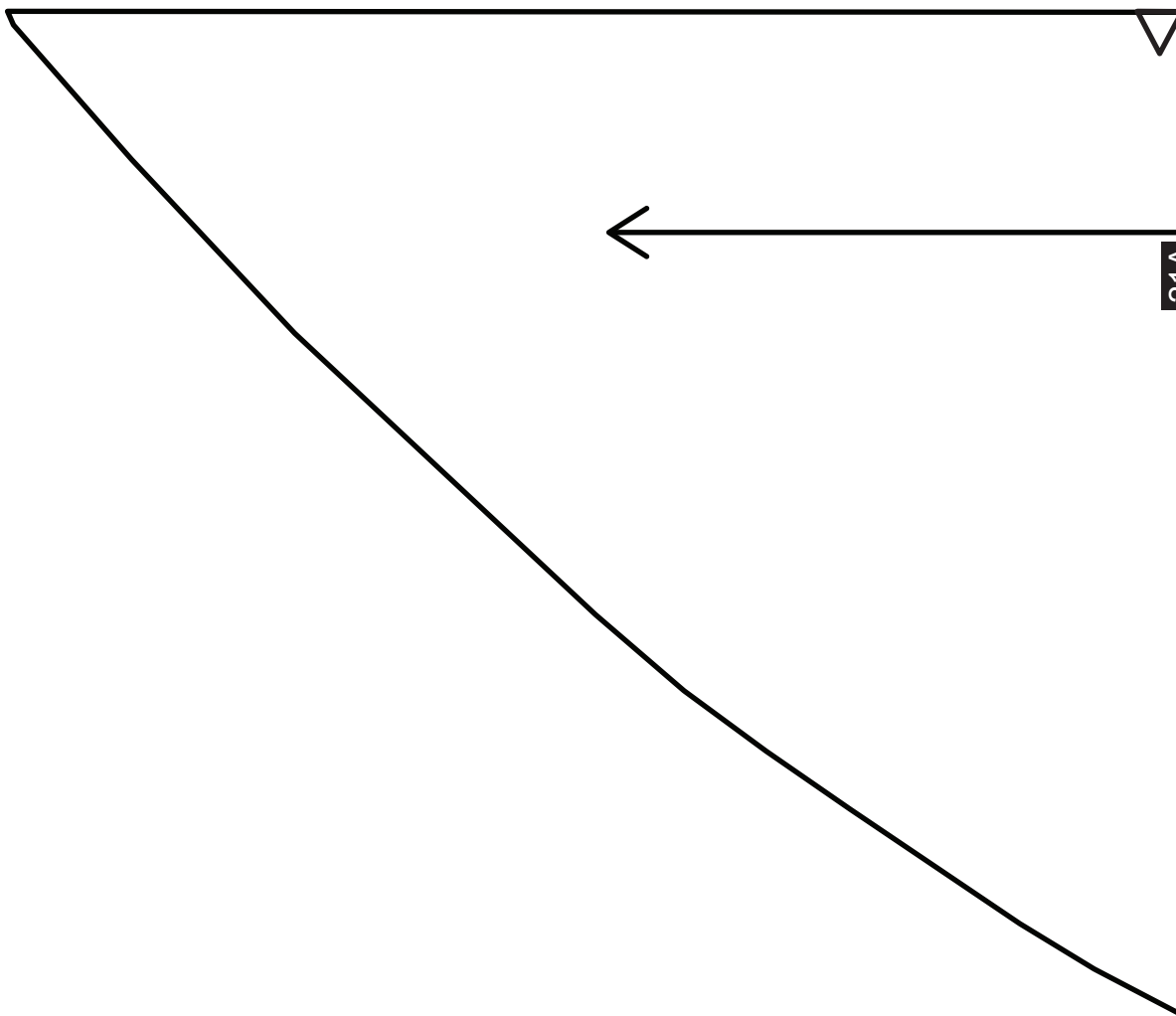

21A

20B

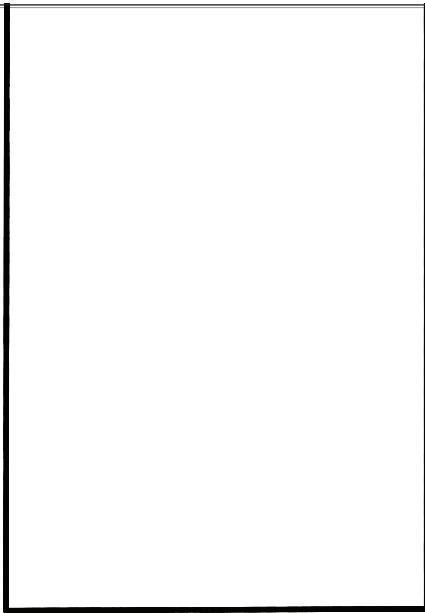

21A

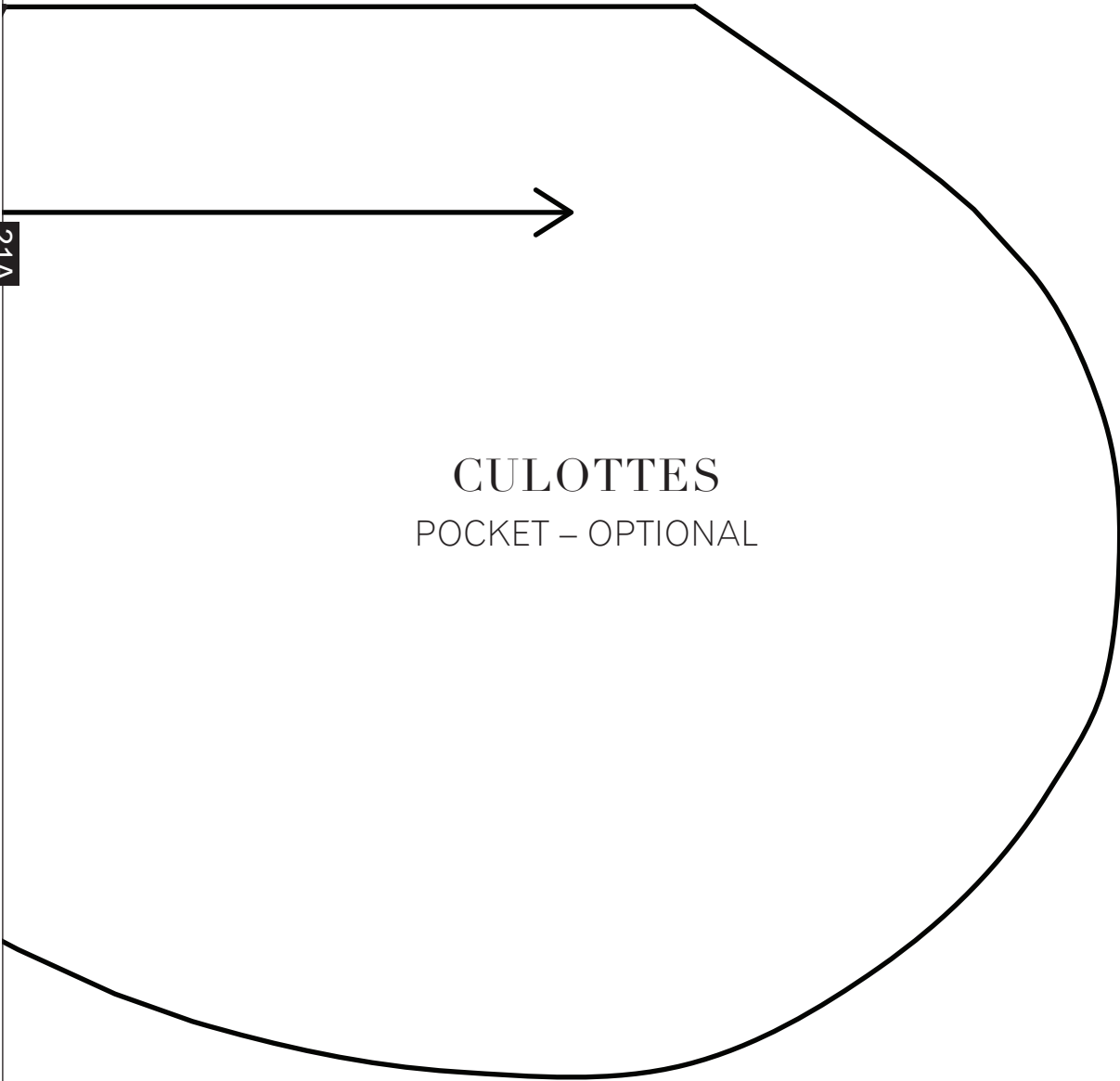

CULOTTES  
POCKET – OPTIONAL